

未注公差/General tolerances (mm)											0.1/10 ±2'		
0 ~ 3	>3 ~ 6	>6 ~ 10	>10 ~ 18	>18 ~ 30	>30 ~ 50	>50 ~ 80	>80 ~ 120	>120 ~ 180	>180 ~ 250	>250 ~ 315		>315 ~ 400	>400 ~ 500
±0.12	±0.18	±0.22	±0.26	±0.31	±0.37	±0.57	±0.80	±0.93	±1.05	±1.15	±1.60	±2.20	±2.50

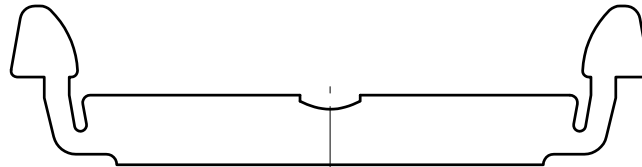
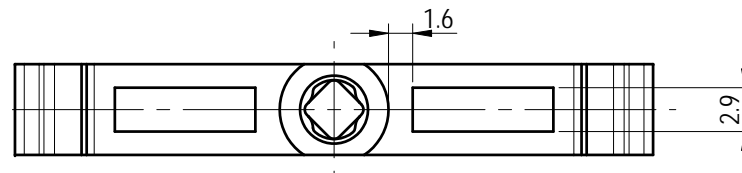
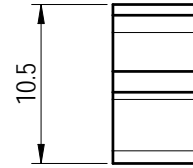
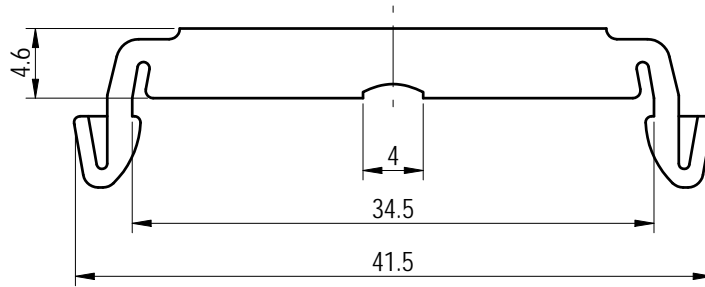
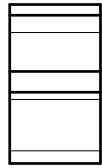
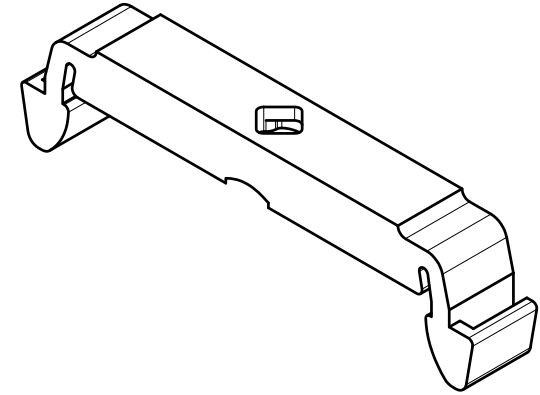
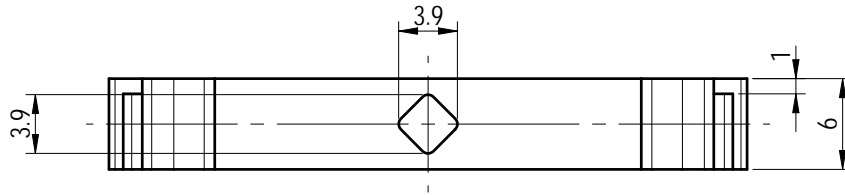

Note:
The A&Z(H) in the name means: A(H) and Z(H).

ITEM	NAME OF PART	MATERIAL	NOTES
1	Housing	PA66	UL94V-0

使用温度范围/Operating temperature(°C)	-40~+105
符合RoHS环保要求/Conform to RoHS	Yes

DEGSON		MATERIAL:	SURFACE/COLOR:
APPD: 兰春华	2023.01.03	MAT NO./REV: / 00	MAT STATUS: 批量
CHKD: 陈招	2023.01.03	NAME DG013-01P-1Y-00A&Z(H)	
DRFT: 龚徐涛	2023.01.03	DRAWING NO. 200029367	TYPE CUSTOMER DRAWING
		DRAWING STATUS 已发布	SCALE 2:1
		SHEET 1/1	

REV	ECN	DESCRIPTION	DRFT	DATE
00			龚徐涛	2023.01.03

Transfer or duplication of this document as well as the utilization or communication of its content are prohibited unless authorized in writing. All rights reserved for patent, utility model or designer registrations. 除专利权明确标注外, 未经许可, 不得复制或传播。 凡在本文件上标注, 未经许可, 不得复制或传播。 凡在本文件上标注, 未经许可, 不得复制或传播。